

ALCATEL-LUCENT ENTERPRISE

WHERE EVERYTHING CONNECTS

WE ARE ALCATEL-LUCENT ENTERPRISE

We make everything connect by delivering **Digital Age Networking**, **Communications** and **Cloud** solutions with services tailored to ensure our customers' success. In the Cloud. On Premises. Hybrid.

2

- ▶ Built-in Security
- ▶ Green IT
- ▶ Scalable
- ▶ Subscription-based



Digital Age
Networking



Digital Age
Communications



Tailored
Services

WE PROVIDE DIGITAL AGE NETWORKING

Autonomous Networks to support Digital Transformation



AUTONOMOUS NETWORKS

Automate mission-critical Network Operations and improve User Experience

- Network Automation
- Mission-critical and secure
- Quality of experience



IOT OUTCOMES

Scale up Digitalisation with Secure IoT Onboarding & Management

- IoT Secure on-boarding
- IoT Management
- IoT Tracking



BUSINESS INNOVATION

Accelerate Transformation with new Automated Workflows

- Real-time Analytics
- Location-Based Services
- Automated Workflows

DIGITAL TRANSFORMATION WITH TARGETED INDUSTRIES

Innovative Connected Solutions for better human experience and business outcomes



Government

Improve Digital Public Services and Citizen Safety



Healthcare

Optimize the Care Pathway for better Patient Outcomes



Education

Empower Student success and affordable Education

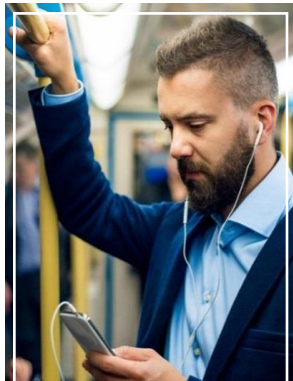

Transportation

Transform Passenger Experience & Service Operations



Energy & Utilities

Maintain High Availability in Harsh Environments



Hospitality

Enhance the Guest Experience & Hotel Services

NETWORK PORTFOLIO

WLAN



AP1201H



AP1201/BG AP12xx



AP1251

OmniAccess Stellar



AP1301H



AP1301



AP13xx



AP136x



AP1451

OmniAccess



AP5xx



AP375



OA4xxx

Tech Partners



LAN

OmniSwitch

Core



OS6900



OS9900

Rugged



OS6865



OS6465/T

Access



OS6860E



OS6360



OS2x60



OS6860N



OS6560



OS6450

IP/MPLS



7750 SR

7250 IXR

VSXR

7705 SAR

7210 SAS

7450 ESS



POL



Management Software

OmniVista 2500
OmniVista Cirrus
UPAM
Proactive Lifecycle Management
Nokia Network Services Platform



Contact Tracing

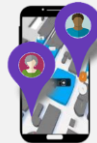

Asset Tracking



SERVICES

NaaS
by ALE

NETWORK SECURITY

THE ALE COMPREHENSIVE LAYERED APPROACH FOR ZERO-TRUST SECURITY

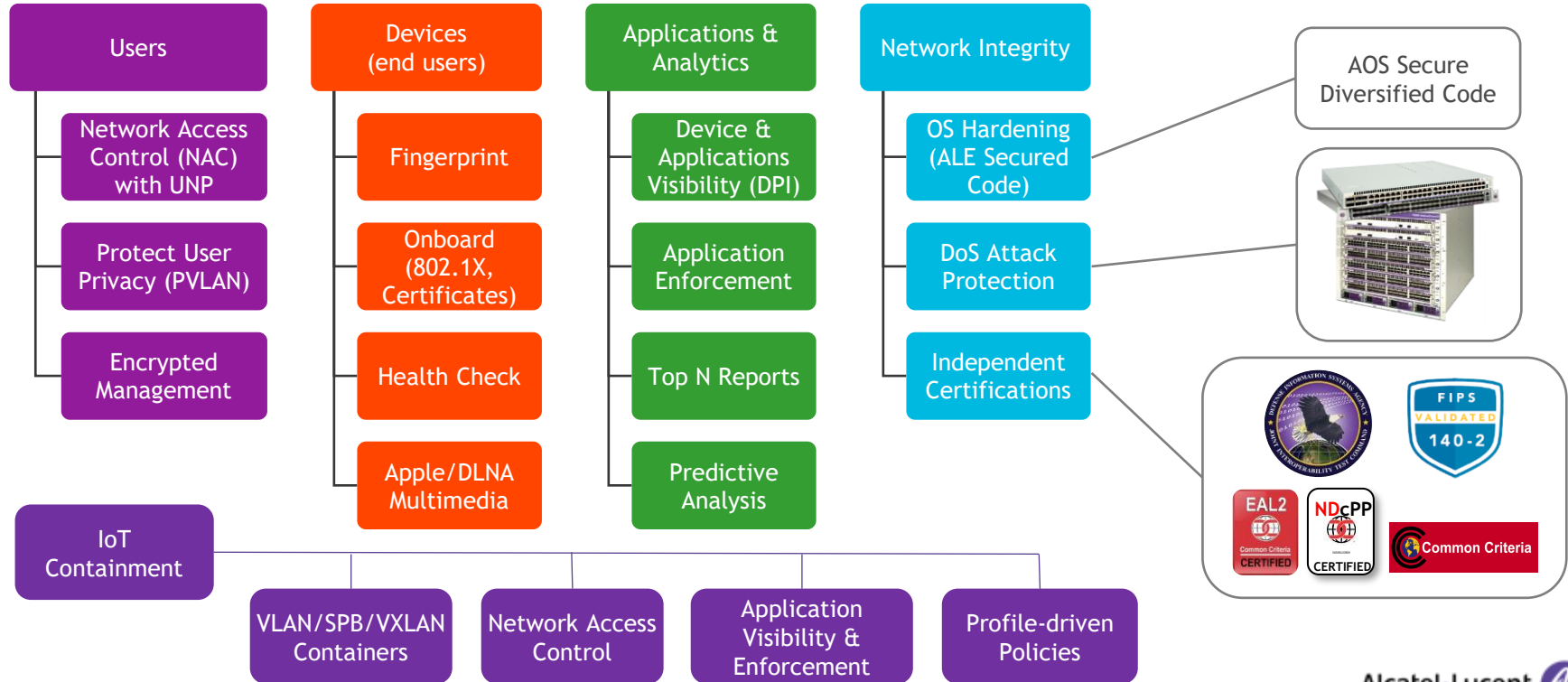

ALE NETWORK PORTFOLIO CERTIFICATIONS

Relevant for Government and Defence



EU GDPR



Interconnected
Electrotechnical
Committee



US Federal Information
Processing Standards
(FIPS)



US Joint
Interoperability Test
Command (JITC)



US MIL-STD
810 / 461



US Trade Agreements
Act (TAA)

NETWORK PORTFOLIO

 = Hardened



OmniVista® NMS & Security



OmniVista Network Advisor



Asset Tracking



OS6860E/N



OS6865



OS6900



OS9900

Core, Datacenter
L3

Advanced Access: 1/2.5/5/10G Core and Datacenter : 1/10/25/40/4x10/4x25/100G

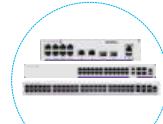

OS6360



OS6560 (Multi-Gig)

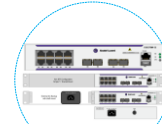

OS6570M



OS6465(T)

Access
L2+

Access : 10/100/1000/2500 Mbit/s 10G PoE: 802.3af 802.3at



AP1411



AP1431



AP1451

Wi-Fi 6E



AP1301



AP1301H*



AP1311



AP132X



AP1331*



AP1351



AP136X

Wi-Fi 6



AP1201



AP1201H



AP1201



AP122X



AP123X



AP1251

Wi-Fi 5

Controllerless Architecture - Operations Optimization - Advanced Features

OMNIACCESS™ STELLAR WI-FI 5 AND WIFI-6/6E LINEUP



Entry Level



AP1301

2x2:2 @ 2.4GHz
2x2:2 @ 5GHz
DPI
2xGE

Premium Entry Level



AP1311

2x2:2 @ 2.4GHz
2x2:2 @ 5GHz
1 scanning radio
BLE/Zigbee, DPI
2xGE, 1xGE down

Mid-Range



AP1321/22

2x2:2 @ 2.4GHz
4x4:4 @ 5GHz
1 scanning radio
BLE/Zigbee, DPI
1x2.5GE + 1xGE

Premium Mid-Range



AP1331

4x4:4 @ 2.4GHz
4x4:4 @ 5GHz
1 scanning radio
BLE/Zigbee, DPI
2x5GE

High-End



AP1351

4x4:4 @ 2.4GHz
8x8:8 @ 5GHz
4x4:4 @ 5GHz
1 scanning radio
BLE/Zigbee, DPI
2x10GE

Hotels, Dorms & RAP



AP1301H

2x2:2 @ 2.4GHz
2x2:2 @ 5GHz
1 GE port
4xGE down (1 PoE)
RJ45 Passthrough, *

Outdoors



AP1361/62/61D

2x2:2 @ 2.4GHz
4x4:4 @ 5GHz
1 scanning radio
BLE/Zigbee, DPI
1x2.5GE + 1 SFP
1 GE PoE device port



High-End



AP1451

4x4:4 @ 2.4GHz
8x8:8 @ 5GHz
4x4:4 @ 6GHz
1 scan radio
BLE/Zigbee, DPI
2x10GE

11



Hotels, Dorms & RAP



AP1201H

2x2:2 @ 2.4GHz
2x2:2 @ 5GHz
1 GE port
3xGE downlink (1 PoE)
RJ45 Passthrough, *

High-End



AP1231/32

4x4:4 @ 2.4GHz
Dual 4x4:4 @ 5GHz
BLE, DPI
1xGE + 1x2.5GE

Outdoors



AP1251

2x2:2 @ 2.4GHz
2x2:2 @ 5GHz
1xGE + 1xGE downlink
DPI

Entry Level



AP1411

2x2:2 @ 2.4GHz
2x2:2 @ 5GHz or @ 6GHz
BLE/Zigbee, DPI
2x1GE

Mid-Range



AP1431

2x2:2 @ 2.4GHz
2x2:2 @ 5GHz
2x2:2 @ 6GHz
BLE/Zigbee, DPI
2x2.5GE

STELLAR WLAN DISTRIBUTED CONTROL

An evolution from controlled based architectures

Controller-based Wi-Fi

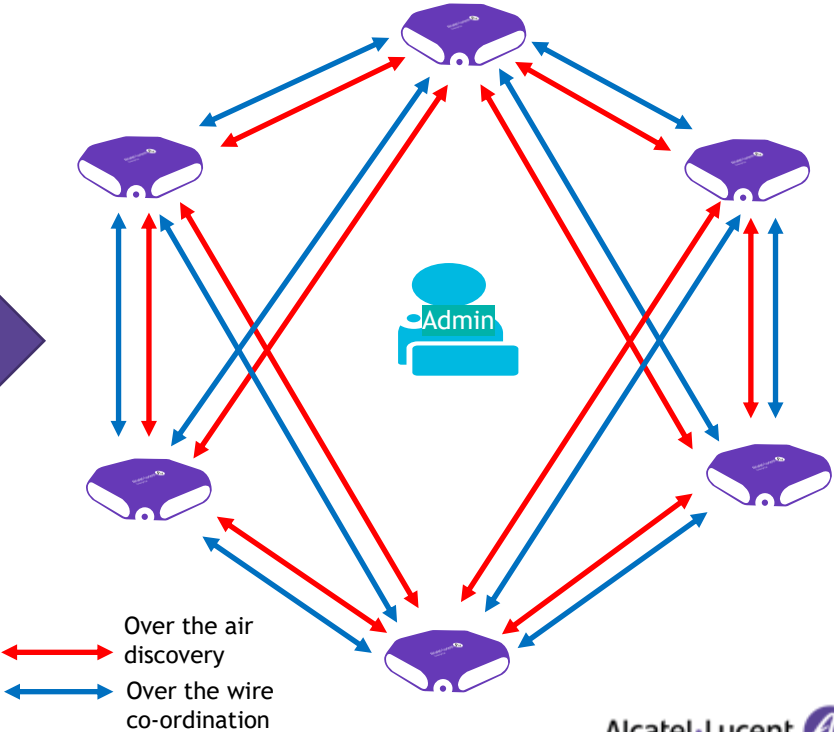
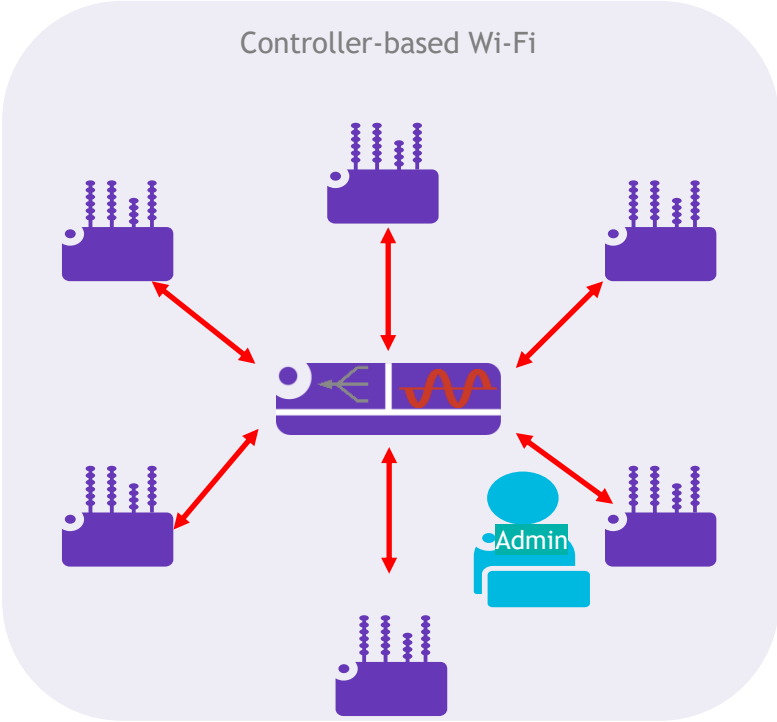

OMNIVISTA NETWORK MANAGEMENT SYSTEM

One system, Two flavours - On Premises & Cloud

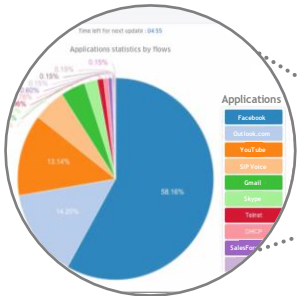

Advanced Analytics

Customizable Dashboard



Topology & Maps



On-premises Network Management System



Cloud-based Network Management System

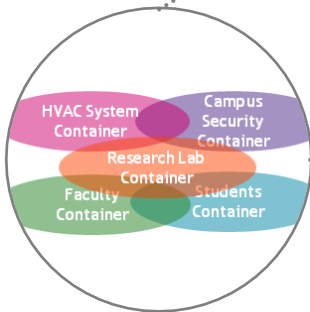

NAC & Security

Unified Management

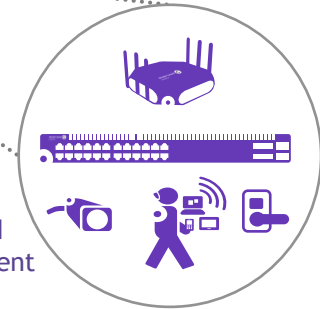

GEOLOCATION OF DEVICES AND IOT

Locating objects for security, maintenance and time savings

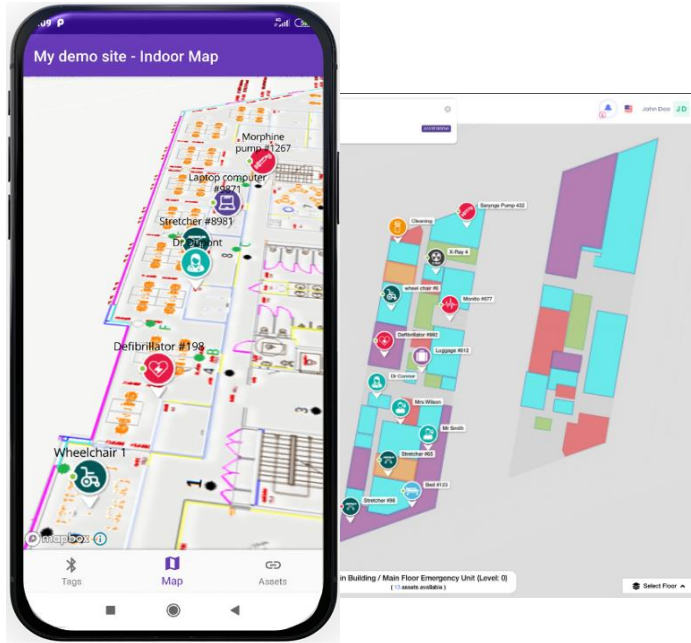

- ▶ Real time accurate location (standard and AI-ML)
- ▶ Improve operational workflows
- ▶ Prevent lost/stolen equipment, save time & costs
- ▶ Facilitate equipment maintenance
- ▶ Accelerate return on investment

Location-aware network



OMNIACCESS STELLAR ASSET TRACKING

APIs to 3rd party applications

OmniVista Cirrus Asset Manager (asset tag manager & location engine)



Applications:

- #1 Increasing the equipment use
- #2 Reducing theft/loss
- #3 Improving maintenance

15

AP1201BG and/or Stellar APs with built-in BLE



Maintenance notifications

Bluetooth Low Energy (BLE) Mobile tags for track



OmniAccess Stellar Asset Tracking mobile app

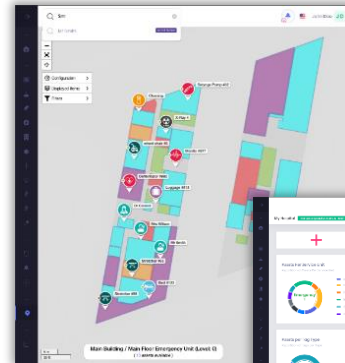

OmniVista Cirrus Asset Manager web manager

- Asset Provisioning
- Asset Search
- Statistics/Analytics
- Geo-notification
- Contact tracing

CONTACT TRACING

Real-time alerts and historic people flow analysis.



Know staff/customers location
Know where people are or have been



Geofencing Notifications
Know when density gets too high in certain areas and get real-time alarms

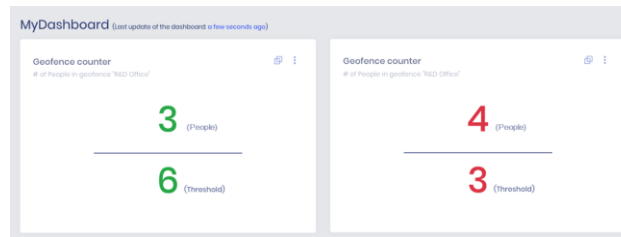

Benefits

- Provide safe guest and staff experience
- Get notifications when people density is too high
- Increase brand recognition by being known as a safe company
- Track people movement in real-time and historic

PEOPLE LOCATION/SAFETY & CONTACT TRACING

#4 Interrupting chains of transmission

Applications: OmniVista Cirrus Asset Manager web manager

APIs to 3rd party applications



Know your density limits and get alerts when those limits are exceeded

17

AP1201BG and/or Stellar APs with built-in BLE



Duress button notifications

Bluetooth Low Energy (BLE)
Mobile tags for track

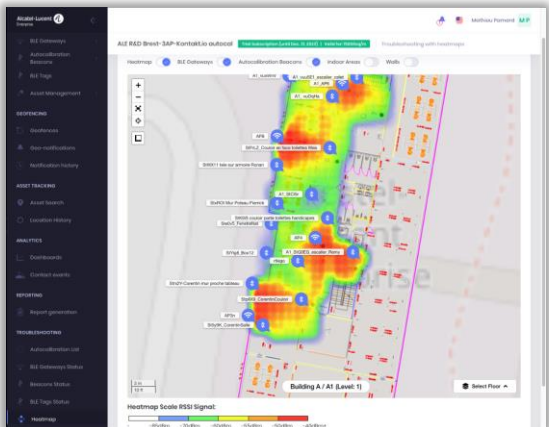

Quickly check people density to ensure people are physical distancing

OUR RECENT CUSTOMER WINS



Okada Manila resort hotel



Nevada Department of Transportation



La Métropole et la Ville de Perpignan



Gotthard Tunnel



WE ARE COMMITTED TO SUCCESSFUL PARTNER RELATIONSHIPS

Global reach, local touch



Channel Partners

100% Indirect Partner Model



Technology Partners

Complementing our offer



Alliance Partners

Extending our expertise

WHY ALCATEL-LUCENT ENTERPRISE?



- Our extensive end-to-end portfolio of network, communications and cloud solutions for enterprise customers
- Our commitment to our go-to-market model through our Business Partners
- Our differentiated vertical focus, recognised by customers and analysts
- Our open industry standards to help streamline development and interoperability
- Our local touch

MEET TEAM AUSTRALIA

CONNECT WITH US

ALE Australia supports the partner and customer community for the Australia, New Zealand & Fiji Region. We have a team of local sales, pre-sales, post-sales and professional services experts as well as partner, business development and services managers. Feel free to connect with us.



Guy Kelly
Network Business Leader

Guy.Kelly@al-enterprise.com
0432 678 941
[LinkedIn](#)



Paul Pan
Partner Manager

Paul.Pan@al-enterprise.com
0412 439 487
[LinkedIn](#)



Nicole Gorman
Partner Manager

Nicole.Gorman@al-enterprise.com
0499 180 414
[LinkedIn](#)



Maud Holvast
Country Business Leader

Maud.Holvast@al-enterprise.com
0429 359 427
[LinkedIn](#)

C O N T A C T U S



WEBSITE

www.al-enterprise.com

Follow us on:

